

## TL-EX-FH-BSP03-Series Explosion-proof Plug and Sockets

### 1 Application and Features

- Explosion protection  
ATEX
- Application in hazardous area  
Zone 1 & 2,  
Zone 21 & 22
- Flame-proof type and dust explosion-proof type structure, used with explosion-proof instruments and meters. Three kinds of pole numbers: 2P, 3P, 4P.
- After the plug and socket are connected by thread locking mode, they have anti-vibration, anti-loosening and anti-misplugging functions.
- Contact performance of the plug is reliable.
- The plug sleeve in the socket has an elastic shutter spring sleeve, which not only makes the plug self-cleaning but also ensures small contact resistance and low temperature rise.
- At the same time, it reduces the required insertion and extraction force to a minimum.
- The design of the shutter spring sleeve ensures normal plug and socket function and permanent self-cleaning.
- The product has timing function; different working voltages are set to different colors to prevent wrong insertion.
- Cable wiring for plug.

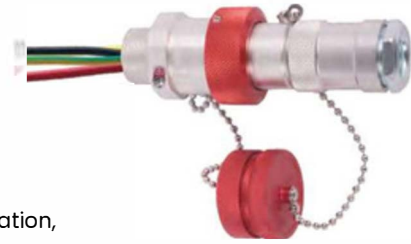



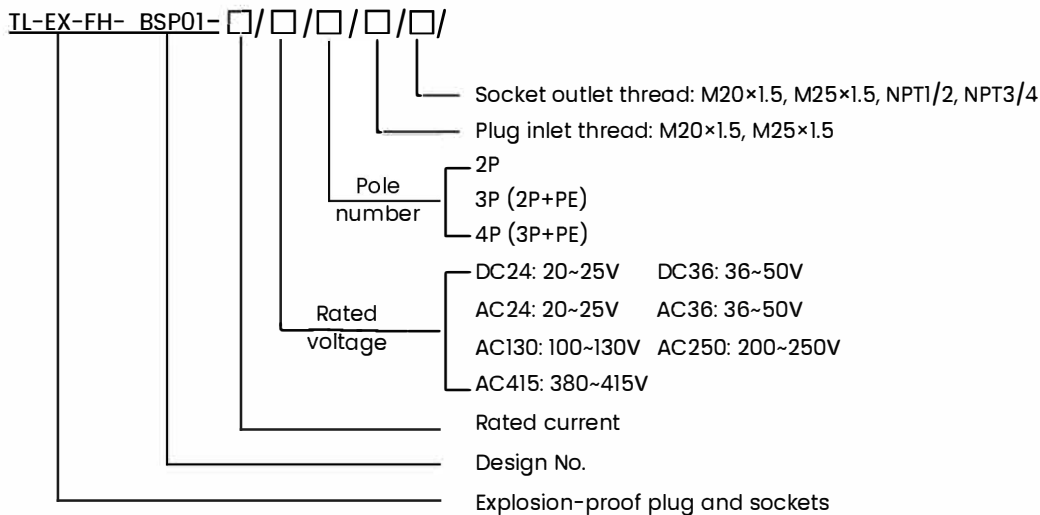



























### 2 Nomenclature



<b>Ex marking</b>	<b>Gas</b>	Ex db IIC Gb	
	<b>Dust</b>	Ex tb IIIC Db	
<b>Conformity to standards</b>	IEC 60079-0, IEC 60079-1, IEC 60079-11, IEC 60079-31 EN 60079-0, EN 60079-1, EN60079-11, EN 60079-31		
<b>Exposed fasteners</b>	Stainless steel		
<b>Rated voltage</b>	20~25V DC, 36~50V DC		
	20~25V AC, 36~50V AC, 100~130V AC, 200~250V AC, 380~415V AC		
<b>Rated current</b>	6A, 10A, 16A		
<b>Pole</b>	2P, 3P (2P+PE), 4P (3P+PE) requencey		
<b>Frequency</b>	50Hz/60Hz		
<b>Degree of protection</b>	IP66, IP68		
<b>Ambient temperature</b>	6A, 10A: -40°C ~ +70°C 16A: -40°C ~ +60°C		
<b>Thread specification</b>	<b>Inlet thread/cable outer diameter (mm)</b>	M20×1.5 / Ø4-Ø10 (Default)	NPT1/2 / Ø4-Ø10
		M25×1.5 / Ø5.5-Ø12	NPT3/4 / Ø5.5-Ø12
	<b>Thread</b>	Socket: M20×1.5 (Default), M25×1.5, NPT1/2, NPT3/4 Plug: M20×1.5 (Default), M25×1.5	

## TL-EX-FH-BSP03-Series Explosion-proof Coupler

### 4 Selection Table

Rated voltage (V)	Pole	Schematic diagram	h	Color	
AC20-25	2P		/	 Purple	
AC36-50			12	 White	
AC20-25			10	 Purple	
AC36-50				 White	
AC20-25	2P+PE		/	 Purple	
AC36-50			12	 White	
AC20-25			10	 Purple	
AC36-50				 White	
AC100-130			4	 Yellow	
AC200-250			6	 Blue	
AC20-25		3P+PE		/	 Purple
AC36-50				12	 White
AC20-25			10	 Purple	
AC36-50				 White	
AC100-130			4	 Yellow	
AC200-250			9	 Blue	
AC380-415			6	 Red	

### 5 Outline and Installation Dimension (Dimensions in mm)

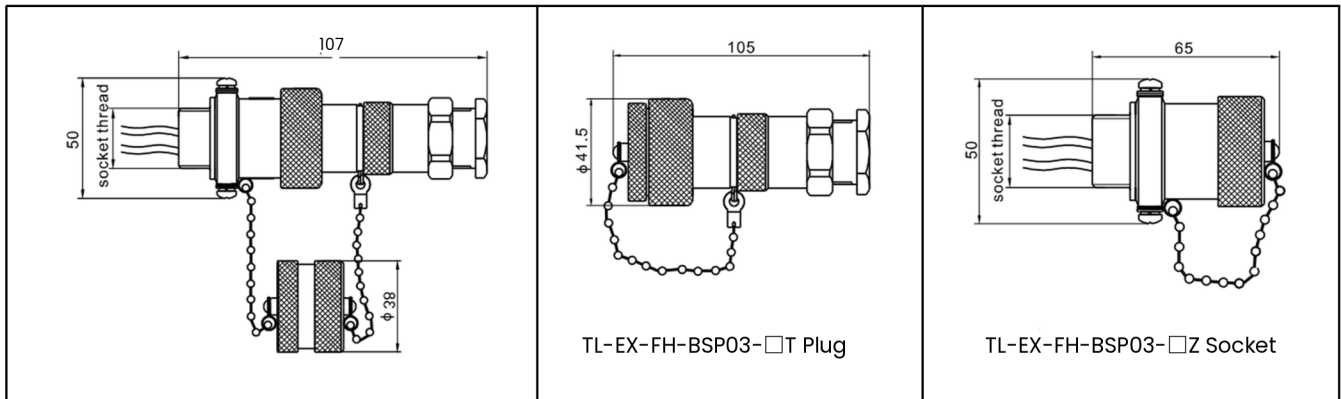

### 6 Wiring Diagram

